

# BACK-TO-BACK SINGLE POST WITH ADJUSTABLE OFFSETS

**MODEL #1534** 5-9/16" O.D. WITH 4' OFFSET (350 LBS)

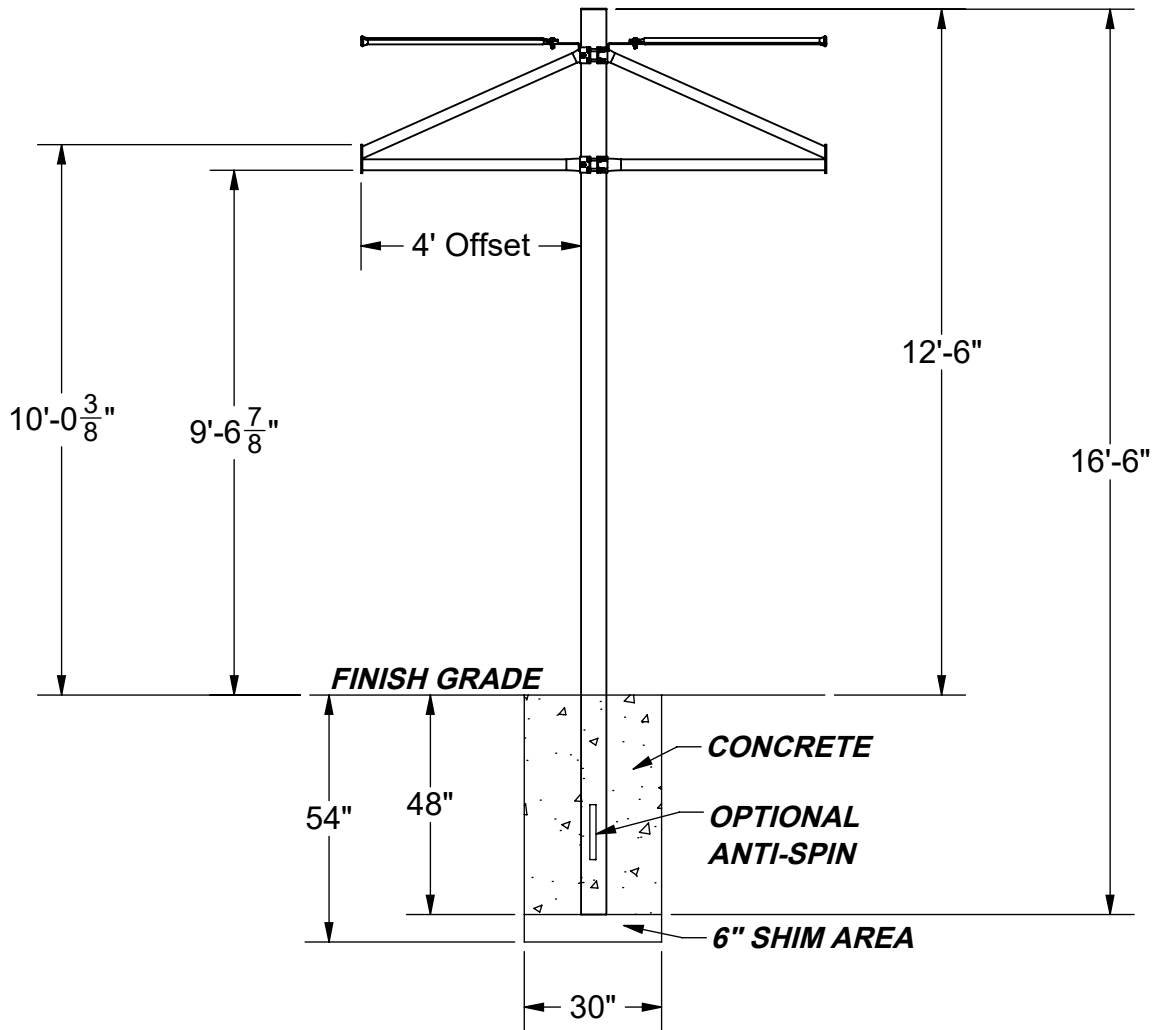

**SPECIFICATIONS:**

A heavy-duty 5-9/16" O.D. galvanized steel upright post with the top end capped which supports an adjustable 4 ft. offset.

The adjustable offset assembly is constructed using two pieces of 2-3/8" O.D. galvanized steel (one horizontally and one diagonally) welded to a 1/4" x 6-1/4" x 6-1/2" steel backboard mounting plate at both ends.

Heavy-duty 1/4" thick half clamps, formed to fit the diameter of the post, are secured to the support post with (8) 1/2" diameter bolts.

A pair of braces made of 1" O.D. galvanized steel are mounted between the backboard and the adjustable offset.

All hardware is zinc-plated for long, rust free service.

Post depths are approximate and should be adjusted to insure that the top of the mounting plate is **10' 0-3/8"** above the finish grade.

Warranty Period: Limited Lifetime

 <p><b>ATHLETIC MFG. CO.</b></p>	Date: 9/14/23	<b>SPECIFICATION/INSTALLATION INSTRUCTIONS</b> BACK TO BACK SINGLE POST WITH ADJUSTABLE OFFSETS
	Rev:	
	Drawn: CW	MODEL NO.
	Sheet: 1 of 2	<b>1534-SPEC</b>

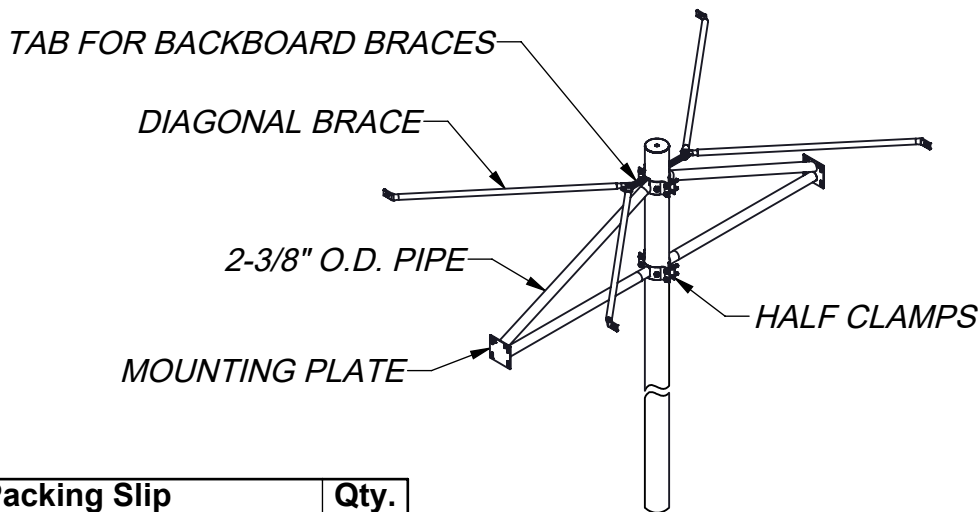

Packing Slip	Qty.
5-9/16" O.D. Post	1
4' Adjustable Offset Assembly	2
Diagonal Braces	4
Hardware Kit	Qty.
3/8"-16 x 2" Hex Bolt	2
3/8"-16 Lock Nut	2
3/8" Flat Washer	4
1/2"-13 x 3-1/2" Hex Bolt	8
1/2"-13 Lock Nut	8
1/2" Flat Washer	16
5/8" x 1" Set Screw	5

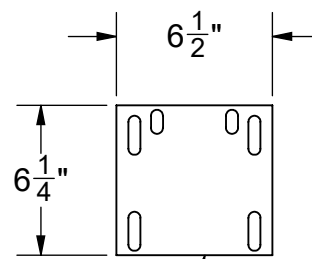

Bottom of Mounting Plate

**INSTALLATION INSTRUCTIONS:**

1. Dig a hole in the desired location per footing chart dimensions (see sheet 1). Set the bottom of the support post in the center of the hole and shim from below and brace so THE CAP IS ON TOP and the top of the post is **12'-6"** above the finish grade. Plumb the post true vertical and brace. Pour the concrete to 2" below finish grade. Allow it to set for 3 days before the removal of the bracing and completion of the installation. Cover the footing with turf or court materials.
2. The adjustable offset assemblies are equipped with half clamps formed to fit the diameter of the post. Single offsets are equipped with back-up half clamps. Set the clamps back-to-back over the post at ground level. Use 1/2" x 3-1/2" hex bolts, washers and lock nuts to attach the clamps to the post. Tighten the hardware slightly.
3. Slide the offset assembly up the post until the top of the backboard mounting plate is 3/8" above the goal ring height desired. Align the offsets with court(s). Tighten the clamp bolts securely. Install 5/8" set screws into the nuts on each of the half clamps and tighten to prevent rotation. **NOTE:** the official goal ring height is 10 feet but the height is adjustable to accommodate various age groups and physically challenged children and adults.
4. Attach both of the straight (non-formed) ends of the diagonal braces to the mounting tab with the 3/8" bolt, washers and lock nut.
5. Attach the other ends of the diagonal braces to the backboard; use the backboard installation instructions if needed. Tighten all the bolts.
6. Install a 5/8" set screw into the top cap to prevent moisture from entering the post.



Date: 9/14/23  
 Rev:  
 Drawn: CW  
 Sheet: 2 of 2

**SPECIFICATION/INSTALLATION INSTRUCTIONS**  
 BACK TO BACK SINGLE POST  
 WITH ADJUSTABLE OFFSETS

MODEL NO.

**1534-SPEC**