

BACK-TO-BACK SINGLE POST W/ADJUSTABLE OFFSETS

MODEL #1562 - 6-5/8" O.D. W/6' OFFSET (532lbs)

SPECIFICATIONS:

A heavy-duty 6-5/8" O.D. galvanized steel upright post with top end capped, that supports an adjustable 6ft. offset.

Adjustable offset assembly is of welded construction consisting of 2 pieces of 2-3/8" O.D. galvanized steel (one horizontally and one diagonally), welded to a 1/4"x6-1/4"x6-1/2" steel backboard mount plate at both ends.

Heavy-duty 1/4" thick half clamps, formed to fit the diameter of the post, secure to the support post with (8) 1/2" diameter bolts.

A pair of braces made of 1-3/8" O.D. galvanized steel are mounted between the backboard and the adjustable offset.

All hardware is zinc-plated for long rust free service.

Warranty Period: Limited Lifetime

Post depth's are approximate, and should be adjusted to insure that the top of the mounting plate is 10' 0-3/8" above the finish grade.

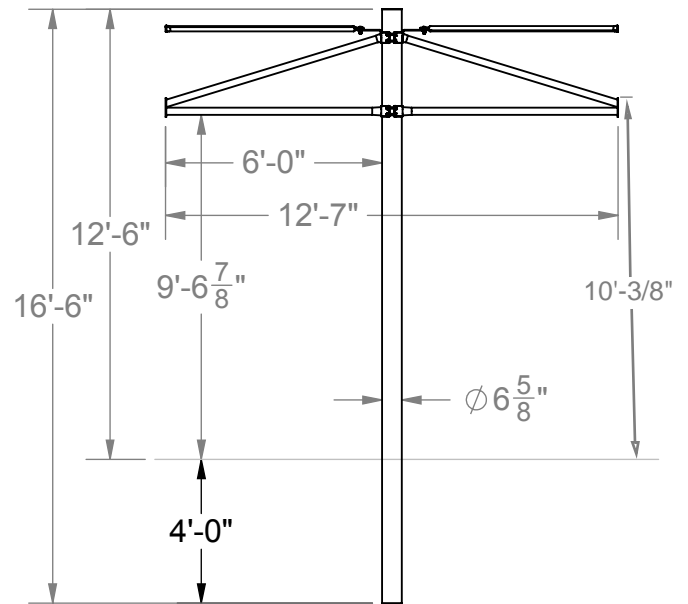
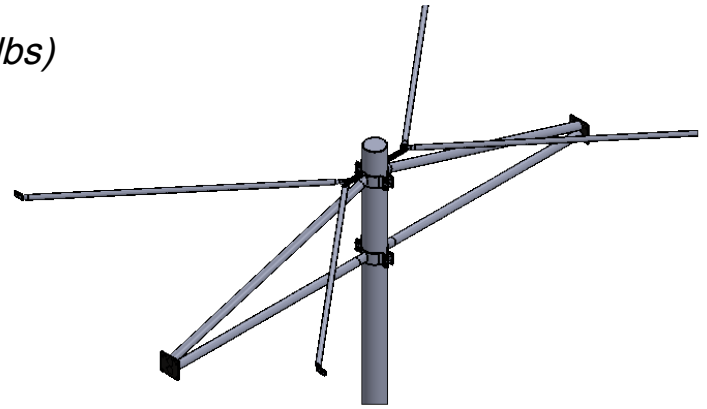

TYPICAL FOOTING DETAIL

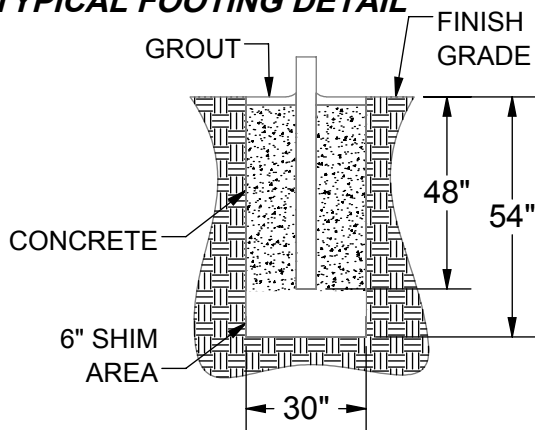

NOTE: Our Offset is measured from the front of post to the front of mtg plate.

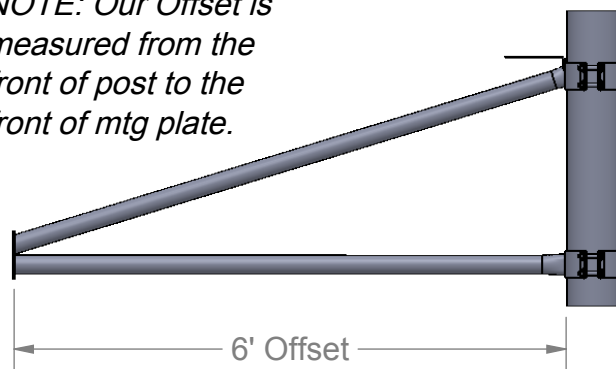

Date: 1/21/2015

Rev: JN4/2/20

Drawn: MT

Sheet: 1 of 2

PRODUCTION SHOP DRAWING

SINGLE POST W/ ADJUSTABLE OFFSET

MODEL NO.

1562

TAB FOR BACKBOARD BRACES

DIAGONAL BRACES

2-3/8" O.D.
GALVANIZED TUBE

P.W. UNIVERSAL
MOUNTING PLATE

HALF CLAMPS TO FIT
MODEL ORDERED

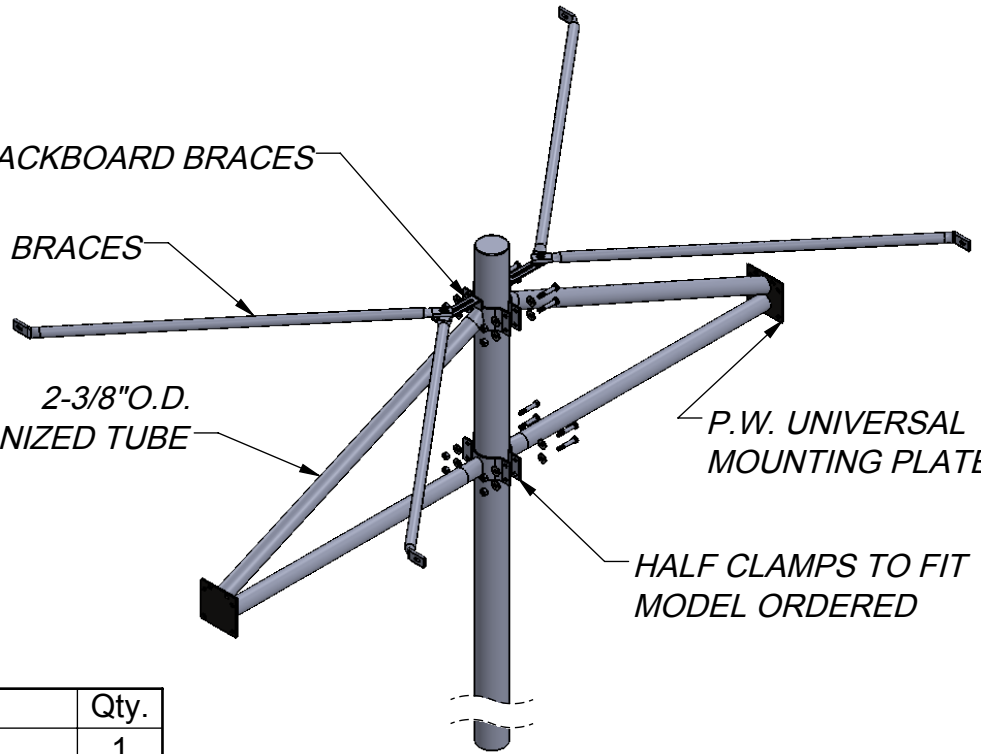

Packing Slip	Qty.
6-5/8" O.D. Post	1
6' Adjustable Offset Assembly	1
Diagonal Braces	2
Hardware Kit	Qty.
3/8"-16 x 2" Hex Bolt	2
3/8"-16 Lock Nut	2
3/8" Flat Washer	4
1/2"-13 x 3-1/2" Hex Bolt	8
1/2"-13 Lock Nut	8
1/2" Flat Washer	16

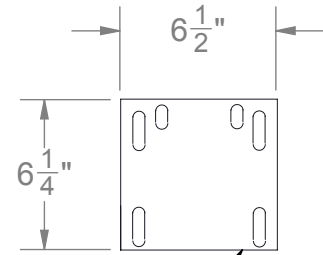

Bottom of Universal
Mounting Plate

INSTALLATION INSTRUCTIONS:

1. Dig a hole in desired location per footing chart dimensions (see sheet 1). Set the bottom of the support post in the hole & shim from below & brace so THE CAP IS ON TOP & the top of the post is 12'-6" above finish grade. Plumb post true vertical & brace. Pour concrete to 2" below finish grade. Allow concrete to set for 3 days before removal of bracing & completion of installation. Cover footing with court materials.
2. Adjustable offset assemblies are equipped w/ half clamps formed to fit the diameter of the post. Single offsets are equipped w/ back-up half clamps. Set clamps back-to-back over the post at ground level. Use 1/2" x 3 1/2" hex bolts, washers & lock nuts to attach (8total are provided). Tighten hardware slightly.
3. Slide the offset assembly up the post until the top of the backboard mounting plate is 3/8" above the goal ring height desired. Align offsets w/ court(s). Tighten clamp bolts securely. Note: Official goal ring height is 10ft, but height is adjustable.
4. Attach 6' braces to offset assemblies. Attach both the straight (non-formed) ends to the mounting tabs.
5. Attach to backboard. Use backboard install for installation instructions.



Date: 1/21/2015

Rev: JN4/2/20

Drawn: MT

Sheet: 2 of 2

PRODUCTION SHOP DRAWING

SINGLE POST W/ ADJUSTABLE OFFSET

MODEL NO.

1562

Pick ticket

Pab to provide post and adjustable offset
Shipping to pull braces hardware and half clamps.

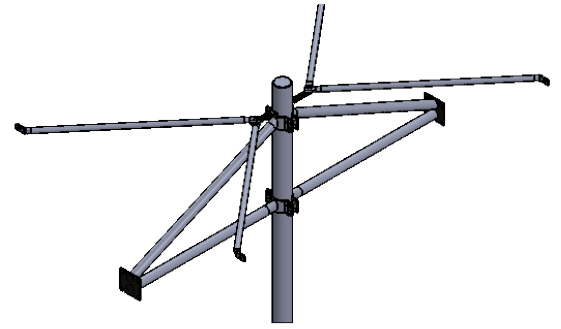

Part Number	Packing Slip	Qty.
	6-5/8" O.D. Post	1
	6' Adjustable Offset Assembly	2
CIADJ6	Diagonal Braces	4
	Hardware Kit	Qty.
HWSC581	5/8" x 1" Zinc Set Screw	1
HWSC3858	3/8" x 5/8" Zinc Set Screw	4
HWHB382	3/8"-16 x 2" Hex Bolt	2
HWLN38	3/8"-16 Lock Nut	2
HWFLWA38	3/8" Flat Washer	4
HWHB12312	1/2"-13 x 3-1/2" Hex Bolt	8
HWLN12	1/2"-13 Lock Nut	8
HWFLWA12	1/2" Flat Washer	16