

# GOOSENECK STYLE FOOTBALL GOALPOSTS

**MODEL #2222-18** 4-1/2" O.D., 18' 6" WIDE WITH A 4' OFFSET,  
COLLEGE GOAL (900 LBS)

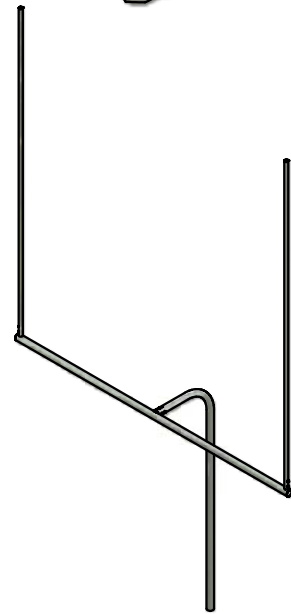
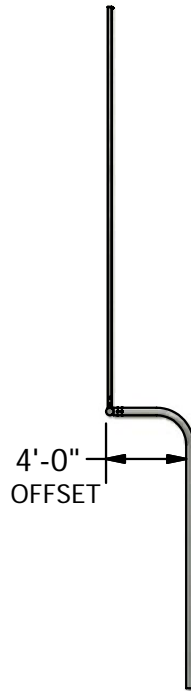
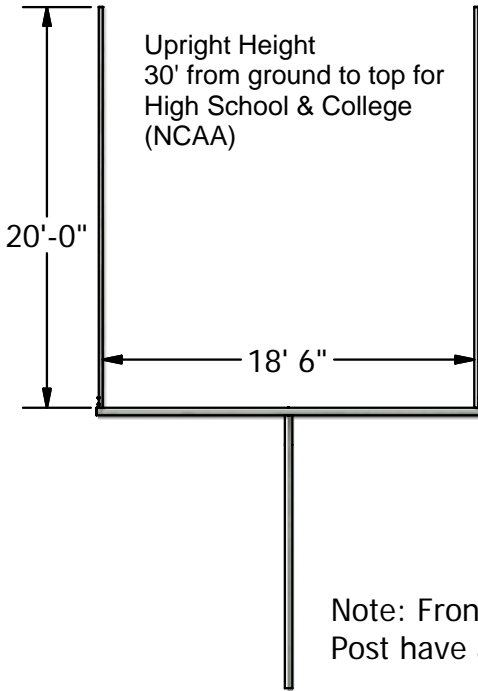
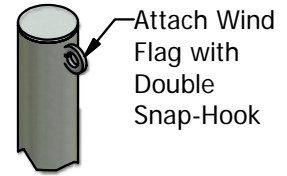

Note: Front Vertical Post have a 4' bury.

## SPECIFICATIONS:

**General:** A pair of heavy-duty NCAA regulation football goals made with a 4-1/2" O.D. steel. Support post extends 4'-0" into concrete footing.

**Materials:** All pipe is galvanized steel.

**Support Post:** Fabricated from a single length of 4-1/2" O.D. steel formed to a 4' offset.

**Crossbar:** Consists of single length of 4-1/2" O.D. galvanized steel. A heavy galvanized steel sleeve is welded to center of crossbar, which fits inside support post and is secured with (4) four 5/8" socket set screws.

**Uprights:** 2-3/8" O.D. galvanized steel. Uprights sleeve over fittings on crossbar upright sleeves and secure with 5/8" socket set screws. Exposed ends are capped.

**Finish:** All welds are ground smooth and treated with cold galvanized compound.

**Warranty Period:** 10 Years

 <p><b>Patterson-Williams</b> ATHLETIC MFG. CO. QUALITY ATHLETIC AND PARK EQUIPMENT SINCE 1919</p>	Date: 08-26-11	<b>SPECIFICATION/INSTALLATION INSTRUCTIONS</b>
	Rev: 120512	
	Drawn: AMC	MODEL NO.
	Sheet: 1 of 2	<b>2222-18</b>

## INSTALLATION INSTRUCTIONS:

1. Dig hole per footing detail approximately 60" for all models behind end line in desired location. Note: The offset is from the inside edge of bent offset post to the outside edge of the crossbar.
2. Insert crossbar into bent offset support post (gooseneck). The gooseneck has four 7/32" pre-drilled holes, two on top and two on bottom, for drive pin insertion. Level crossbar and use 7/32" drill bit to drill through the crossbar. Insert all four 1" drive pins. Tighten set screws to hold in place. Center support post in footing hole. Block, plumb and brace so the top of the crossbar is 10 feet above finish grade. Make sure crossbar is directly over the end line.
3. After checking that goal is plumb and square to field, pour concrete to within 2" of finished grade. Brace to hold in position. Let concrete set for 3 days before removal of bracing.
4. Sleeve uprights onto upright sleeve welded stubs. Tighten set screws to hold in place. Note: Attach wind flags to top of upright with brace bands provided. (See Drawing Sheet 1)
5. Cover exposed footings with turf.

Component Description	Qty
1/4" Hex Key Wrench (1/2" Setscrew)	1
5/8"-11 X 7/8" Setscrew (Support Post)	8
5/16" Hex Key Wrench (5/8" Setscrew)	1
1/4" Drive Pins	8
Wind Flag	4
Double Snap Hooks	4

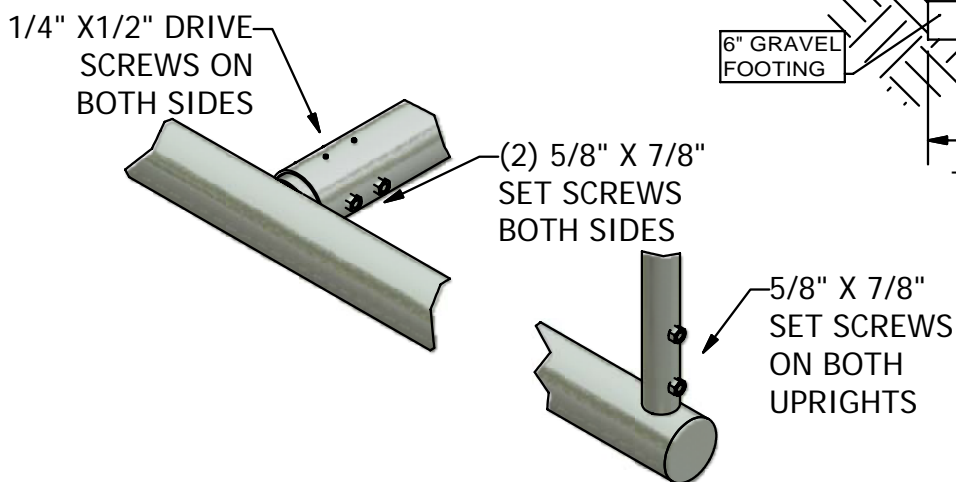
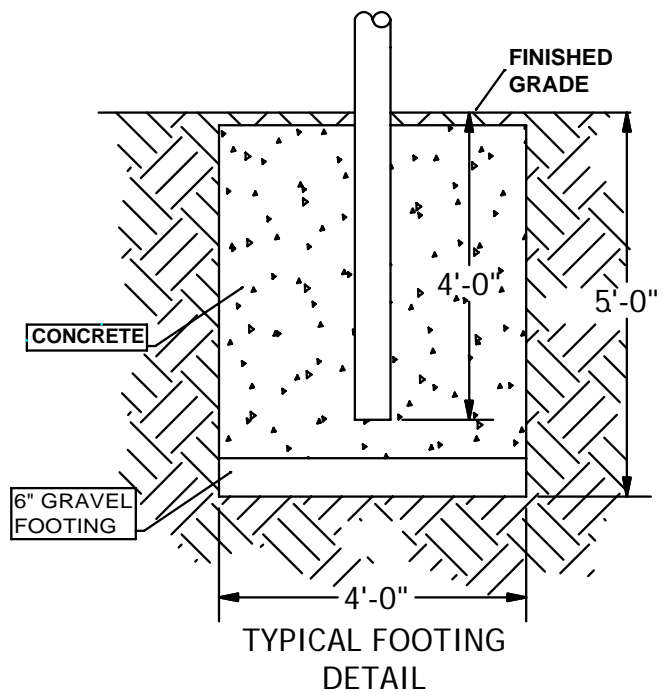

Date: 08-26-11  
 Rev: 120512  
 Drawn: AMC  
 Sheet: 1 of 2

**SPECIFICATION/INSTALLATION INSTRUCTIONS**  
 GOOSENECK STYLE GOALPOST  
 MODEL NO.

**2222-18**